

Description

The DCSD24C is designed to replace multilayer varistors (MLVs) in portable applications such as cell phones, notebook computers and PDA's, using monolithic silicon technology to provide fast response time and ultra low ESD clamping voltage, making this device an ideal solution for protecting sensitive semiconductor components from damage. The DCSD24C complies with the IEC 61000-4-2 (ESD) standard with $\pm 30\text{kV}$ air and $\pm 30\text{kV}$ contact discharge. It is assembled into a lead-free SOD-323 package and will protect one bidirectional line. These devices will fit on the same PCB pad area as an 0805 MLV device.

Mechanical Characteristics

- ◆ Package: SOD-323
- ◆ Lead Finish: Matte Tin
- ◆ Case Material: "Green" Molding Compound.
- ◆ UL Flammability Classification Rating 94V-0
- ◆ Moisture Sensitivity: Level 3 per J-STD-020
- ◆ Terminal Connections: See Diagram Below
- ◆ Marking Information: See Below

Dimensions and Pin Configuration

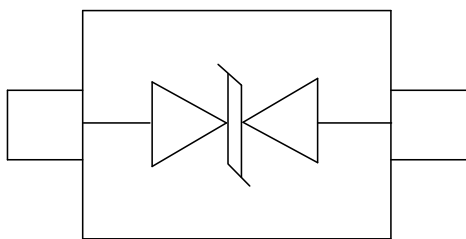

Circuit and Pin Schematic

Features

- ◆ 300W peak pulse power (8/20 μs)
- ◆ Protects one data or power line
- ◆ Ultra low leakage: nA level
- ◆ Operating voltage: 24V
- ◆ Ultra low clamping voltage
- ◆ Complies with following standards:
 - IEC 61000-4-2 (ESD) immunity test
Air discharge: $\pm 30\text{kV}$
Contact discharge: $\pm 30\text{kV}$
 - IEC61000-4-4 (EFT) 40A (5/50ns)
 - IEC61000-4-5 (Lightning) 6A (8/20 μs)
- ◆ RoHS Compliant

Applications

- ◆ Cellular Handsets and Accessories
- ◆ Personal Digital Assistants
- ◆ Notebooks and Handhelds
- ◆ Portable Instrumentation
- ◆ Peripherals
- ◆ Pagers Peripherals
- ◆ Desktop and Servers

Marking Information



24 = Device Marking Code

Ordering Information

Part Number	Marking	Packaging	Reel Size
DCSD24C	24	3000/Tape & Reel	7 inch

Absolute Maximum Ratings ($T_A=25^{\circ}\text{C}$ unless otherwise specified)

Parameter	Symbol	Value	Unit
Peak Pulse Power (8/20 μs)	Ppk	300	W
Peak Pulse Current (8/20 μs)	Ipp	6	A
ESD per IEC 61000-4-2 (Air) ESD per IEC 61000-4-2 (Contact)	VESD	± 30 ± 30	kV
Operating Temperature Range	TJ	-55 to +125	$^{\circ}\text{C}$
Storage Temperature Range	Tstg	-55 to +150	$^{\circ}\text{C}$

Electrical Characteristics ($T_A=25^{\circ}\text{C}$ unless otherwise specified)

Parameter	Symbol	Min	Typ	Max	Unit	Test Condition
Reverse Working Voltage	VRWM			24	V	
Breakdown Voltage	VBR	27			V	IT = 1mA
Reverse Leakage Current	IR			0.2	μA	VRWM = 24V
Clamping Voltage	VC			50	V	Ipp = 6A (8 x 20 μs pulse)
Junction Capacitance	CJ			20	pF	VR = 0V, f = 1MHz

Typical Performance Characteristics (TA=25°C unless otherwise Specified)

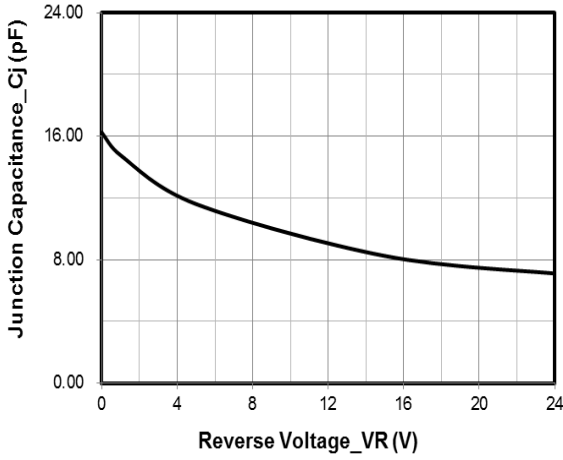

Junction Capacitance vs. Reverse Voltage

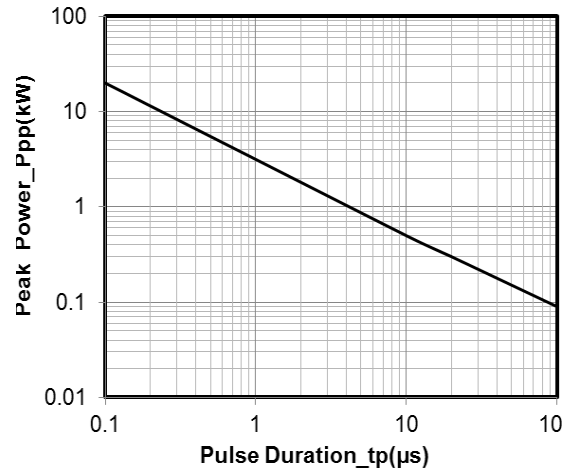

Peak Pulse Power vs. Pulse Time

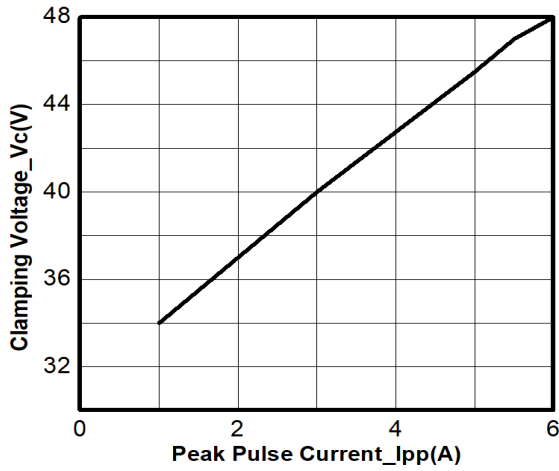

Clamping Voltage vs. Peak Pulse Current

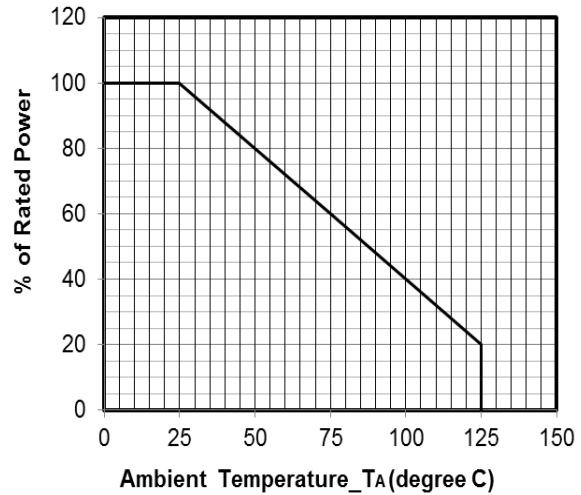

Power Derating Curve

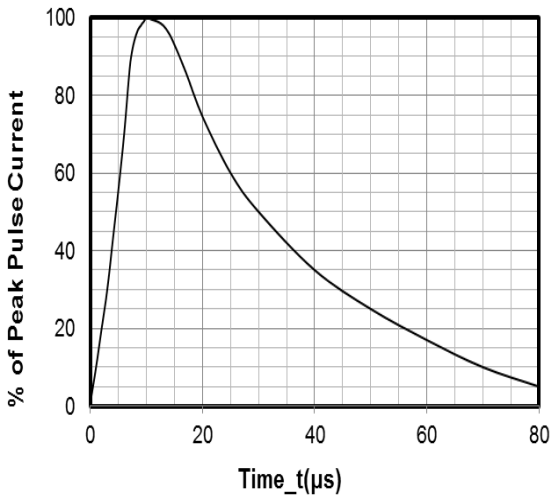

8 X 20μs Pulse Waveform

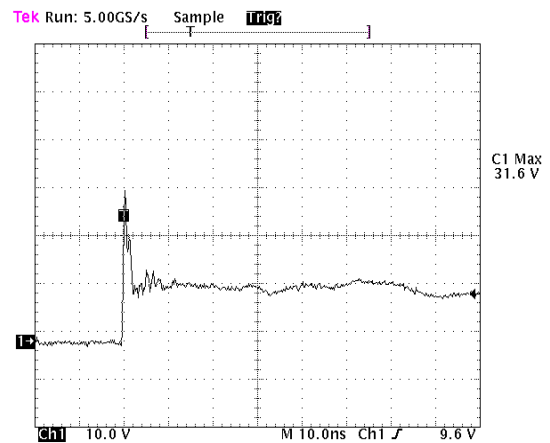

Note: Data is taken with a 10x attenuator

**ESD Clamping Voltage
8 kV Contact per IEC61000-4-2**

SOD-323 Package Outline Drawing

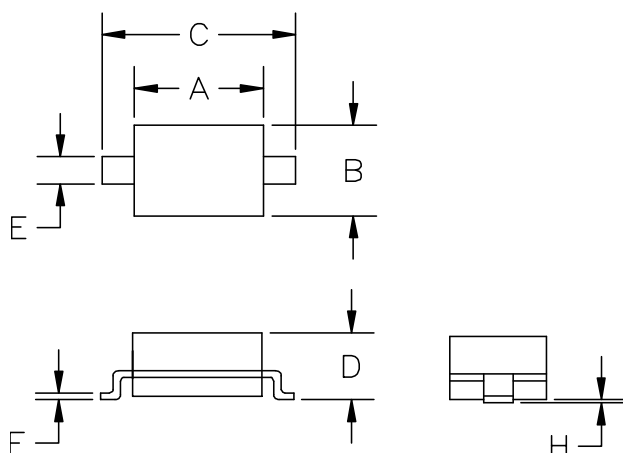

SYM	DIMENSIO			
	MILLIMETERS		INCHES	
	MIN	MAX	MIN	MAX
A	1.50	1.80	0.060	0.071
B	1.20	1.40	0.045	0.054
C	2.30	2.70	0.090	0.107
D	-	1.10	-	0.043
E	0.30	0.40	0.012	0.016
F	0.10	0.25	0.004	0.010
H	-	0.10	-	0.004

Suggested Land Pattern

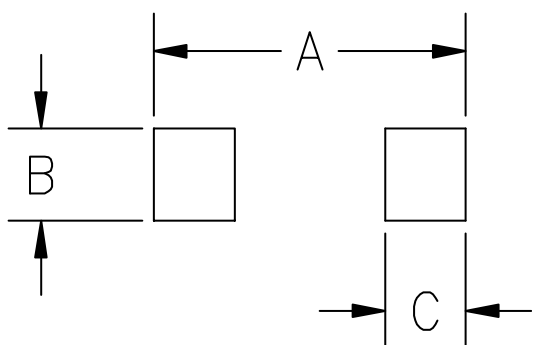

SYM	DIMENSIONS	
	MILLIMETERS	INCHES
A	3.15	0.120
B	0.80	0.031
C	0.80	0.031

Contact Information

Changzhou D-first Electronics CO.,Ltd.

www.first-electronic.com

Email: xhf@first-electronic.cn

Phone: +86 (0519) 8817 1671